

INTRO

Thank you for choosing a GATEMAN product.

We welcome you to this new door solution world of GATEMAN that is the leading brand in the world digital door lock industry.

Please find comfort and security in yourself through perfectly combined digital and analog technologies presented by GATEMAN.

This user manual enables you to operate the product more convenient and safer.

Be sure to read this completely before using it.

CONTENTS

Getting Started

Safety Cautions	4
Product Features	5
Simplified Directions	6

Instructions

Components Overview	8
Identification	9
How to Use	10
Password	
iButton key	
Lock Door	
Open Door from Inside	
Settings	14
Setting it on Manual Lock Mode Alarm	
Volume Setting Feature	
Forced Lock	
Auto / Manual Feature	
Safety Feature	17
Alarm Feature	
3-minute Lock Feature	
Open Door with fake Password	

Extra Features

Option	20
Remote Control Module	
Remote Control	
Emergency Power	22
Emergency Power Supply for Discharged Batteries	
Product Specification	23

Safety Cautions

Must Read This!!!

Please read this carefully for your own safety.

Do not install the unit in outdoor environment.



Do not attempt to disassemble the unit by yourself. That can cause an electronic shock and product damage.

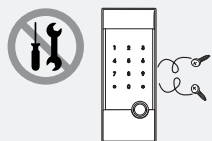

Do not use water and any type of solvent such as gasoline or benzene as they can cause damage to electronic circuit, deterioration and or paint peel-off.

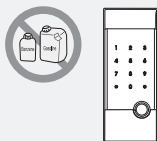

Do not use an inappropriate tool that can cause damage or malfunction of the product.

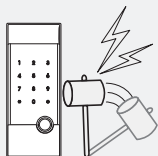

Please keep your Password safely.



Make sure the door is securely locked whenever you leave your house, especially in the manual lock mode.

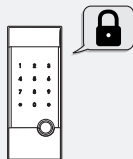

Keep foreign materials away from the fingerprint sensor to maintain it cleanly and do not use it with wet fingers.

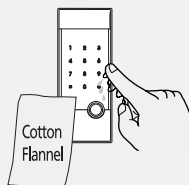

Caution Make sure to follow the above instructions to avoid any injuries or damages on the properties .

Product Features

1 Smart Pad Feature

A separate lighting method where each keypad number has been separately designed is applied so that users may examine intuitively how the selected function is operated and if they are run normally.

2 Floating ID technology

The iButton key in the product applies Floating ID technology, that generates new encryption code in every use.

3 Easy re-registration of keys

If you lose a key, you can invalidate the lost key by re-registering all other keys. You can register up to 20 iButton keys to add users.

4 Verification with the palm

The security code is verified by palm touching to randomize any fingerprint residues on the keypad so protect from exposing it.

5 Remote control (Option)

You can use the remote control by installing the applicable remote control module. This option may not be available depending on your country or local dealer.

Quick Instruction

1 Register Password

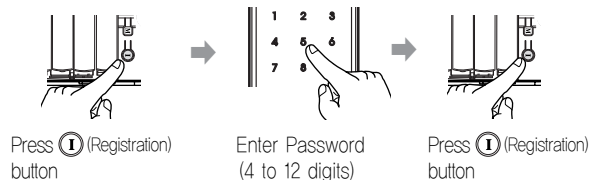

2 Register iButton key

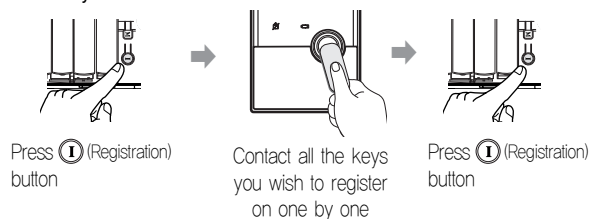

3 Locking the Door from the outside

- ① The automatic Lock Sensor detects the door closing and locks the door within 5 seconds, or
- ② Touch the keypad with the palm

4 Unlocking the Door from the outside

- ① Contact the iButton key on key reader, or
- ② Wake up the lock with the palm touch, enter the security code and retouch the lock with the palm.

5 Locking / Unlocking the Door from the inside

- ① Press open / close Button
- ② Turn the Manual thumb turn to lock / unlock

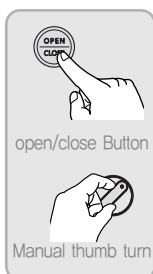

6 Set Auto/ Manual Lock Mode

Be the Auto/Manual Lock Setting button released in the back body to set Auto



Be the Auto/Manual Lock Setting button pressed in the back body to set Manual

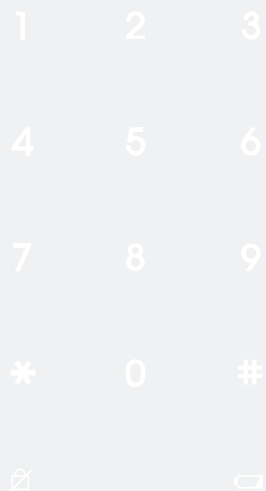

Instructions

Components Overview	8
Identification	9
How to Use	10
Password	
iButton key	
Lock Door	
Open Door from Inside	
Settings	14
Setting it on Manual Lock Mode Alarm	
Volume Setting Feature	
Forced Lock	
Auto / Manual Feature	
Safety Feature	17
Alarm Feature	
3-minute Lock Feature	
Open Door with fake Password	

Components Overview

Basic Contents

The contents of this product may be subject to change without notice for performance or quality improvement.

Basic Contents

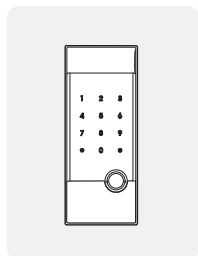

Front (Front Body)



Back (Main Body)

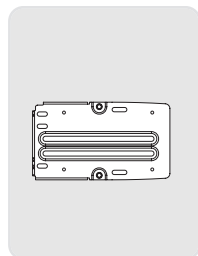

Main Bracket

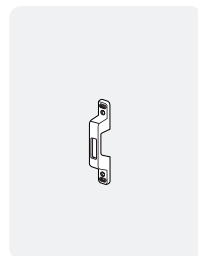

Strike



Users Guide

iButton keys
Batteries
Screws
Installation Template

Option

- Remote control
- Remote control module

Identification

Front

(Front Body, install on the outside of the door)

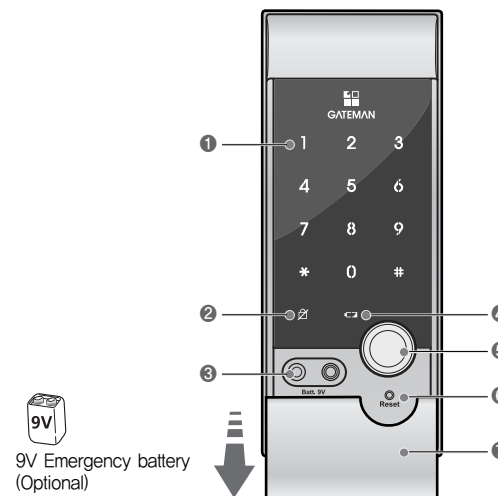

1	Keypad (10-Key)
2	Dead Bolt Jam Lamp
3	Emergency Power Supply Terminal
4	Low Battery Indicator
5	iButton Key Reader
6	Reset Button
7	Emergency Cover

Back

(Back Body, install on the inside of the door)

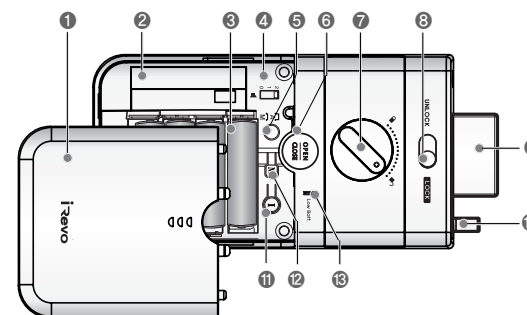

1	Battery Cover
2	Remote Control Module Slot (Option)
3	1.5V AA Alkaline Batteries
4	Volume Control Switch
5	Auto / Manual Lock Button
6	Open / Close button
7	Manual Thumb Turn
8	Forced Lock Switch
9	Dead Bolt
10	Edge Bolt (Auto Lock Sensor)
11	ⓘ Registration Button
12	Ⓜ Menu Button
13	Low Battery Indicator

How to Use



To Use Password

Passwords should be selected from 4 to 12 digits, [*] and [#] are not allowed.

>> To Register Password

Order	Play	Description
1 Press  (Registration) button		Open the battery cover in the back body and press  (Registration) button once.
2 Enter the Password		Enter the Password you wish to register. (4 to 12 digits)
3 Press  (Registration) button		Press the  (Registration) button in the back body again to complete the Password registration.

>> To Open Door with Password

Order	Play	Description
1 Touch with palm		Touch the keypad of the front body gently with your palm.
2 Enter Password		Enter the registered Password in the keypad.
3 Touch with palm		Touch the keypad of the front body gently with your palm or press [*] button to end.







Note

- Make sure to leave the door open when registering a Password because you may accidentally lock a door while trying to register or change a Password the first time.
- The previously registered Password will automatically be deleted when the new Password is registered.
- When registering a Password, the registered Password will be displayed on the keypad (Smart Pad) in sequential order and, then, be disappeared.

How to Use

To Use iButton key

>> To Register iButton key

Order	Play	Description
1 Press  (Registration) button		Open the battery cover in the back body and press  (Registration) button once.
2 Contact all the iButton keys you wish to register on the iButton key reader one by one		If you hear a "pik" sound, the iButton keys are registered. If you hear a "ti-to-ti-to" sound, the iButton key had been already registered.
3 Press  (Registration) button		Press the  (Registration) button in the back body again to complete the Password registration.

>> To Open Door with iButton key

Order	Play	Description
Enter iButton key		Contact iButton key

Check the door opening



Make sure to examine if the door opens normally with the registered Password after the registration is complete.



Note

- Keep the door open while you register iButton key to prevent yourself from accidentally getting locked out.
- The previously registered iButton key will automatically be deleted when the new iButton key is registered.
- When registering the iButton keys, Keypad displays the number of registered iButton keys.



How to Use

Lock Door

» To Close Door from Outside

Order	Play	Description
Auto Lock status		The built-in Auto Lock sensor automatically locks a door within 5 seconds after closing the door.
Manual Lock status		Touch the keypad in the front body gently with your palm to lock a door.

» To Close Door from Inside

Order	Play	Description
Auto Lock status		The built-in Auto Lock sensor automatically locks a door within 5 seconds after closing the door.
Manual Lock status		Turn the Manual thumb turn to Close side to lock a door.
		Press Open/Close button

Note

- Even after a door was locked by the Auto Lock function, please check again if the door was completely closed and locked.

How to Use

Open Door from Inside

» Press Open/Close button

Press Open/Close button

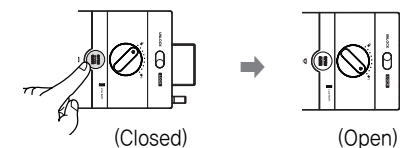

» Using Manual thumb turn in Emergency

Turn manual thumb turn to Unlock to open the lock.

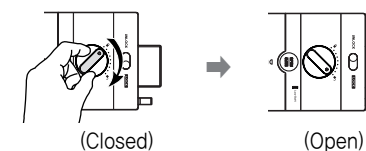

Settings

Manual Lock Mode Alarm

In the default setting, manual lock mode does not ring off the alarm when it unlocked by manual thumb turn.

However, the users can change it for their own security need.

» Toggling the Manual Lock Mode Alarm Setting

Order	Play	Description
1 Press M button		Press M Button inside of battery cover
2 Press 0, 8 button		Press 0, 8 button on the keypad
3 Press M button		Press M Button inside of battery cover to change the setting

Volume Setting

It enables you adjust the volume of various sounds from the product.

» Volume Setting

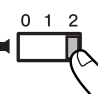
Order	Play	Description
To set volume switch		The operation sound loudness is adjusted according to the Volume Switch Setting. (2 : Louder / 1 : Lower / 0 : Mute)

Note

- Even when the operation sound is set as 'Mute,' the error and alarm sounds will go off.



Settings

Forced Lock

» Outside Forced Lock Setting – iButton key

Order	Play	Description
Contact iButton key		Contact the iButton key on iButton key reader for 5 seconds until you hear 3 beeps.

» Outside Forced Lock Setting – Password

Order	Play	Description
1 Touch with palm		Touch the keypad of the front body gently with your palm.
2 Enter Password		Enter the registered Password on the keypad.
3 Press # button for 5 seconds		Press the [#] button for 5 seconds. (The beeping sound sets off for 3 times.)

» Inside Forced Lock Setting

Order	Play	Description
Set / Release Inside Forced Lock Switch		When the door is closed, move the Inside Forced Lock Switch to LOCK position so that a red sticker can be seen.

Note



- If you try to open a door with the Manual thumb turn from inside while the Outside Forced Lock is set, the alarm goes off.
- If the Inside Forced Lock is set, any attempt to open a door from outside whether it'd be a iButton key or a Password won't work.
- When setting the Outside/Inside Forced Lock, enter the number on the keypad (Smart Pad) and the numbers will flicker from left to right and repeat twice.

Settings

Automatic / Manual Lock Setting

Auto Lock setting locks a door within 5 seconds after the door is closed.

» To Set Auto/Manual Feature

Order	Play	Description
Auto Lock Setting		Be the back body Auto/Manual Setting button released to set Auto
Manual Lock Setting		Be the back body Auto/Manual Setting button pressed to set Auto

Note

- Even after a door was locked by the Auto Lock function, please check again if the door was completely locked.

Safety Feature

Alarm Feature

The alarm sound continues for 30 minutes or until it is disarmed.

» Break-in / Damage Alarm

Break-in: When someone tries to Break-in by opening a door when it is locked, the alarm will go off.

Damage: When the front body was damaged due to forced separation or drilling, the alarm will go off.



Release Trespass/Damage Alarm

- Method 1** Enter the registered Password.
- Method 2** Enter the registered iButton key.
- Method 3** Press the interior ① button for 5 seconds.

» High Temperature Alarm

• When there's fire, it detects the temperature of the inside. It not only goes off an alarm but also releases the lock status automatically.

• Even when the Inside Forced Lock mode is set, the High Temperature Alarm releases the lock status automatically.



Release High Temperature Alarm

- Method 1** Enter the registered Password.
- Method 2** Enter the registered iButton key.
- Method 3** Press the interior ① button for 5 seconds.

Note

- If a door is open when the Auto Lock is not properly operated, the Trespass Alarm might go off.
- If the Back body is exposed to direct sunlight for a long time, the temperature sensor may operate and go off an alarm.
- Even when the Inside Forced Lock mode is set, the lock status will automatically be released if the High Temperature Alarm goes off.
- If the alarm goes off due to damage, fire, or trespass, the numbers on the keypad will light up clockwise. (It repeats the status for 30 minutes with alarm sound.)

Safety Feature

3-minute Lock Feature

At 3-minute Lock mode, no button, besides those in the back body, will work.

>> 3-minute Lock Mode Display

- If a Password or a iButton key that is yet to be registered is entered for 5 consecutive times, 3-minute Lock mode is on and nothing will work for 3 minutes.

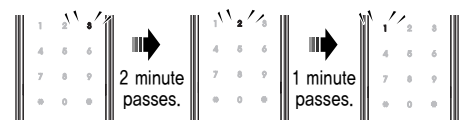

To Release 3-minute Lock

Method ① Press the Open/Close button.

Method ② Press the Back body ① button.

3 minute Lock starts. The number [3] lights up. 2 minutes left. The number [2] lights up. 1 minutes left. The number [1] lights up.

Open Door with fake Password

It is the most effective feature when you are concerned about your Password being accidentally exposed when you have company or in the similar situations.

>> To Open Door with fake Password

Order	Play	Description
① Touch with a palm		Touch the keypad with your palm gently.
② Enter the fake Password and a Password		Method ① Enter the fake Password → Password Method ② Enter the Password → fake Password
③ Touch with a palm		Touch the keypad with your palm gently or press [*] button to end.

Note

- 3-minute Lock mode won't affect any alarm and is sustained even after the product is rebooted.
- Once 3-minute Lock mode is on, the fake Password mode won't work until the next normal verification (iButton key verification, normal Password, open door from inside). In this case, please open a door with your correct Password.

Extra Features

Option 20

Remote Control Module

Remote Control

Emergency Power 22

Emergency Power Supply for

Discharged Batteries

Product Specification 23

1 2 3

4 5 6

7 8 9

* 0 #

⌂ □

Option

Remote Control Module

Buy the Remote control Module and install it to link the remote control.

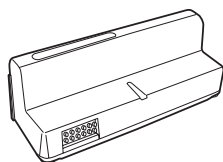

Remote control Module

» Install Remote Control Module

1 Remove batteries

Open the battery cover in the back body and remove all batteries.

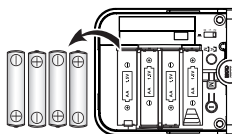

2 Install Remote Control Module

Equip the Remote control Module to the slot.

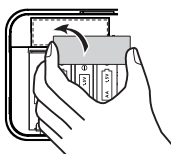

3 Insert batteries

Insert all the batteries by checking the (+, -) connector.

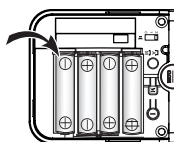

4 Confirm the installation

If you hear a 'ting-a-ling' sound, the Remote control Module has been installed correctly. Close the battery cover.

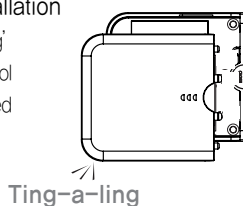

Note

- The operation status may only be examined through the remote control.

Option

Remote Control(Optional)

Not only FSK method but also the wireless encryption algorithm has been applied.

» To Register Remote Control

Order	Play	Description
1 Press M button		Open the battery cover in the back body. Press M button.
2 Enter number 0 and 5 on the keypad		Enter the number 0 and then, 5 button on the keypad.
3 Register Remote Control		Press the SET button of the remote control
4 Press M button		Press the M button in the back body again to complete the procedure.

» To Release Remote Control

Order	Play	Description
1 Press M button		Open the battery cover in the back body. Press M button.
2 Enter number 7, 5 on the keypad		Enter the number 7, 5 on the keypad.
4 Press M button		Press the M button in the back body again to complete the procedure.

Note





- The wireless encryption algorithm resorts to the floating ID technology where the wireless Password is changed every time the remote control is operated.

Emergency Power

Emergency Power Supply for Discharged Batteries

You may open a door by contacting the 9V battery

» To Supply Emergency Power

Order	Play	Description
1 Contact the 9V battery		Open the emergency cover. Keep contacting the 9V battery onto the emergency power supply terminal.
2 Touch with palm		Touch the keypad of the front body gently with your palm.
3 Enter the registered Password.		Enter the registered Password.
4 Press * button		Press the * button. (Please maintain the 9V battery contact until the motor activation is completed)

» To Replace Battery

1 Expiry Period

The product uses four 1.5V(LR6) alkaline AA batteries.
They may sustain 1 year if used 10 times a day.
(Users are advised to use authentic alkaline batteries.)



2 Low Battery Alarm

You must replace all 4 batteries for the following cases:

- * The Low Battery Lamp on the front body lights on
- * The Low Battery Lamp on the back body flickers red
- * The alarm melody goes off
(a nursery rhyme starting with ting-a-ling melodies)

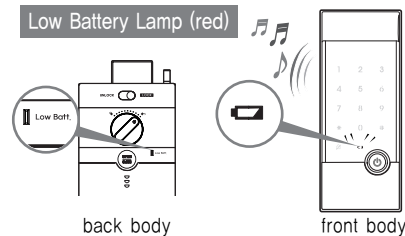

Note

The battery duration varies in the temperature, humidity, the number of use, and the quality of the battery.

Specifications

Specifications

Parts		Specifications	Remarks
Front (Front Body)		19(D)×64.6(W)×160.2(H) Zinc die-casting	Operating temperature : -15~55°C (5~131 °F)
Back (Main Body)		36(D)×85(W)×158(H) Fiber-glass plastic	
Battery		4EA 1.5V AA alkaline batteries (Operating voltage: 4.5 ~ 6 V)	Last up to 1 year (10 times used a day)
Option	Remote Control	Wireless	Optional

※ Battery life may vary depending on temperature, moisture levels, frequency of use and the quality of the batteries.

※ Please make sure that all parts are included when purchasing the product.

※ Optional products may not be available depending on your country or local dealer.

※ **RISK OF EXPLOSION IF BATTERY IS REPLACED BY AN INCORRECT TYPE. DISPOSE OF USED BATTERIES ACCORDING TO THE NATIONAL CODE OR RECYCLING PROGRAM.**